

# TVV 46

HiFi-Entzerrer-Vorverstärker

Hi-Fi Equalizer Pre-amplifier

Préamplificateur-Correcteur à haute fidélité

Preamplificador-ecualizador Hi-Fi

Bedienungsanleitung

Instruction Manual

Notice d'emploi

Instrucciones de manejo

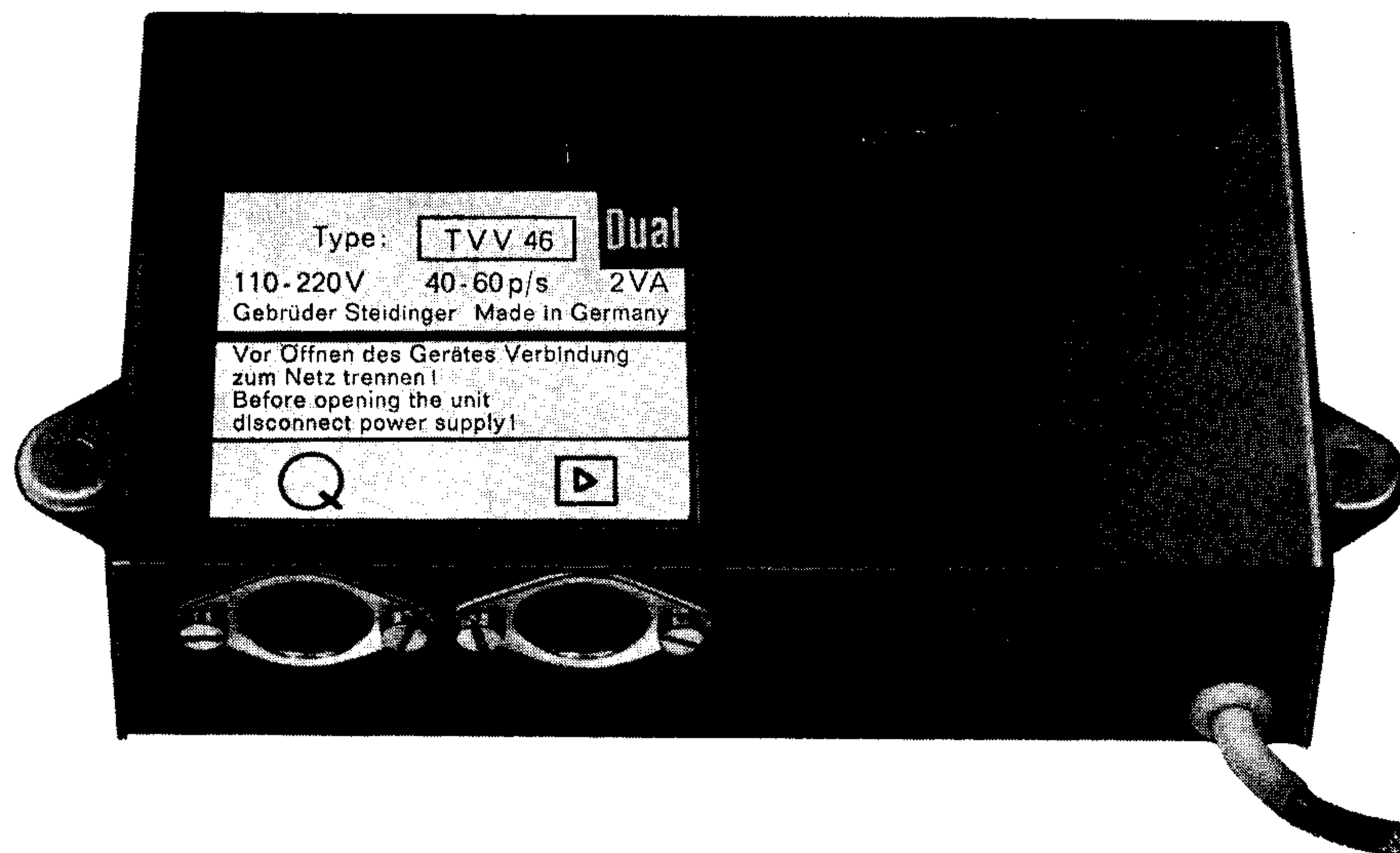

**Dual**

Fig. 1

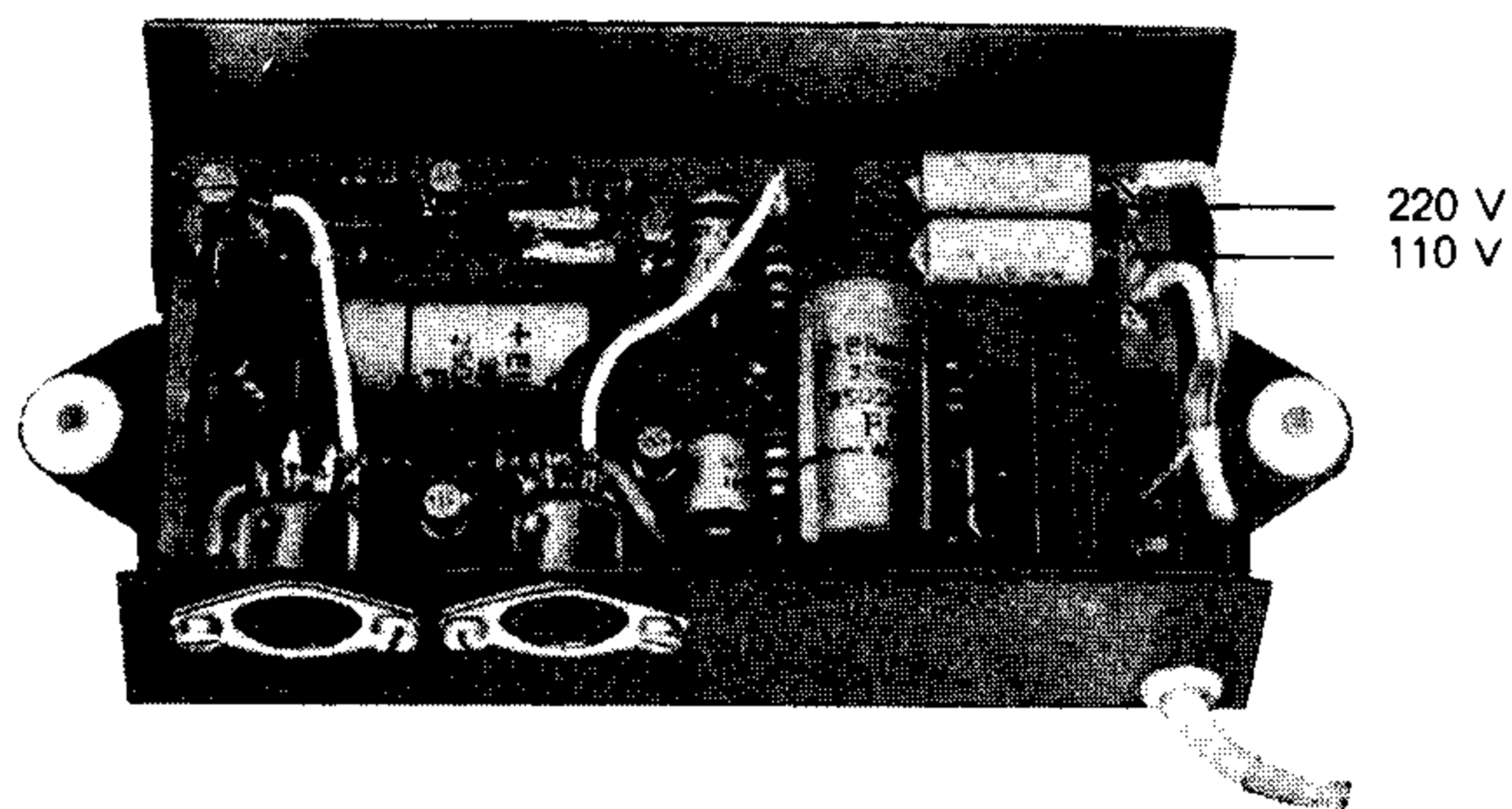

Fig. 2

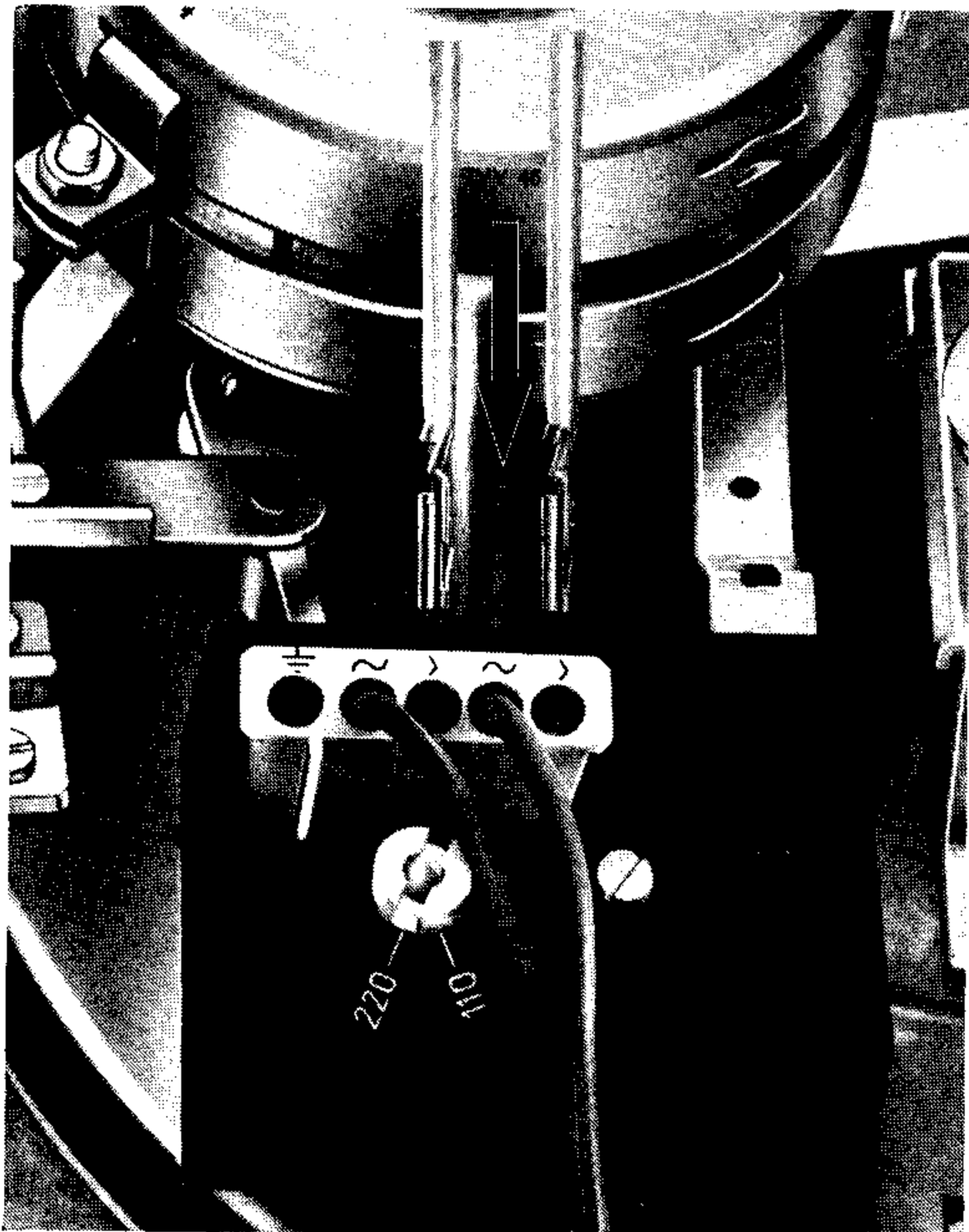

Fig. 3

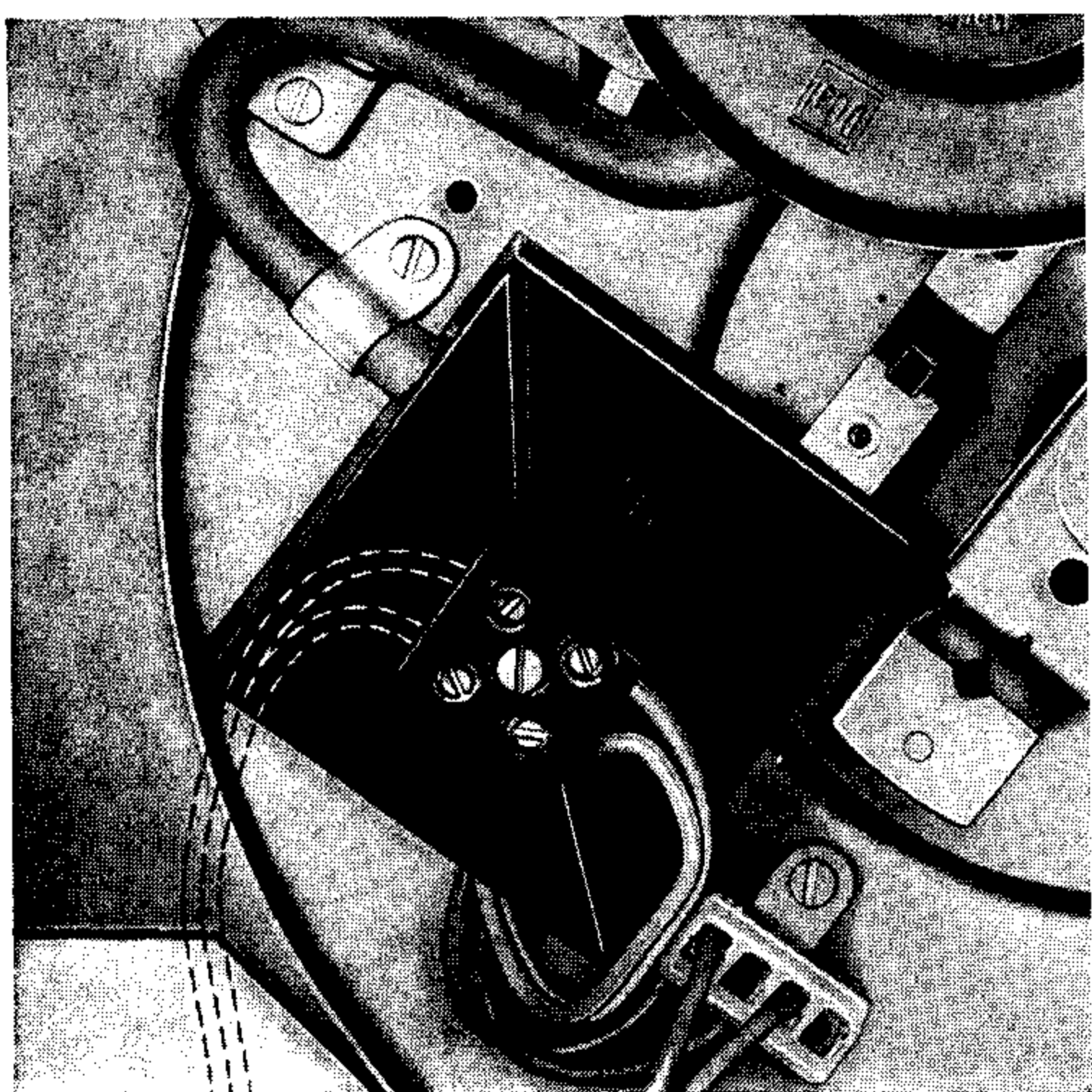
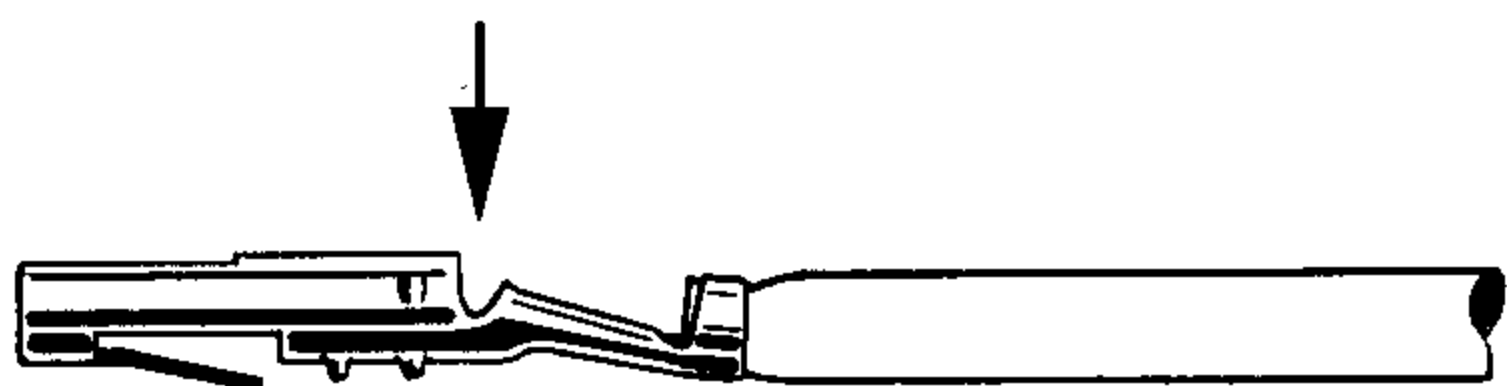

Fig. 4



The Dual-Stereo-Transistor Pre-amplifier TVV 46 enables a phono mechanism with Magnetic Cartridge to be used with an Amplifier not containing an input for a magnetic pickup.

The Dual TVV 46 amplifies the output of the magnetic cartridge and delivers a correctly equalized output signal.

This unit meets or exceeds all the requirements of DIN 45 500 for Home-Studio equipment (Hi-Fi).

## 1. Power supply

Before connecting to power line, check line voltage. The TVV 46 is normally shipped connected for 220 V. To change the line voltage, remove the protective cover and unsolder the connecting cable (Fig. 1).

**Caution — disconnect from power line before opening unit.**

### a) Connection to Dual High Fidelity Record Player with 5-contact power line plug (Fig. 2)

For the direct connection of the TVV 46, use the connection points provided on the line switch of the record player marked: >.

Disconnect the power line plug from the line switch and insert the adapter plugs of the power connection cable into the boreholes of the plug until they lock. Then connect the power line plug again with the line switch of the record player.

### b) Connection to Dual High Fidelity Record Player with clamp connector (Fig. 3)

If the TVV 46 is to be connected to a high fidelity record player equipped with a clamp connector terminal, separate the adapter plugs of the power line cable at the point indicated (Fig. 2).

Separate the power line plug of the record player from the power line, and push the cable of the TVV 46 into the clamp connector, then tighten it with a screw driver.

### c) Connection to the Dual High Fidelity Record Player using solder connections

Some special production runs of Dual Hi-Fi units do not have a clamp connector. Connect the power line cable of the TVV 46 to clamp connectors 5 and 6 of the power switch in units without voltage selector, or to connectors 7 and 8, if the unit has a voltage selector. (See schematic in the record player operating manual.)

### d) Connection to phono units in general

When the TVV 46 is used with another phono mechanism, it is recommended that power be supplied via the line switch on the record player or on the main amplifier so that all will be turned on or off together.

If need be, the TVV 46 can also be plugged in directly into a power receptacle.

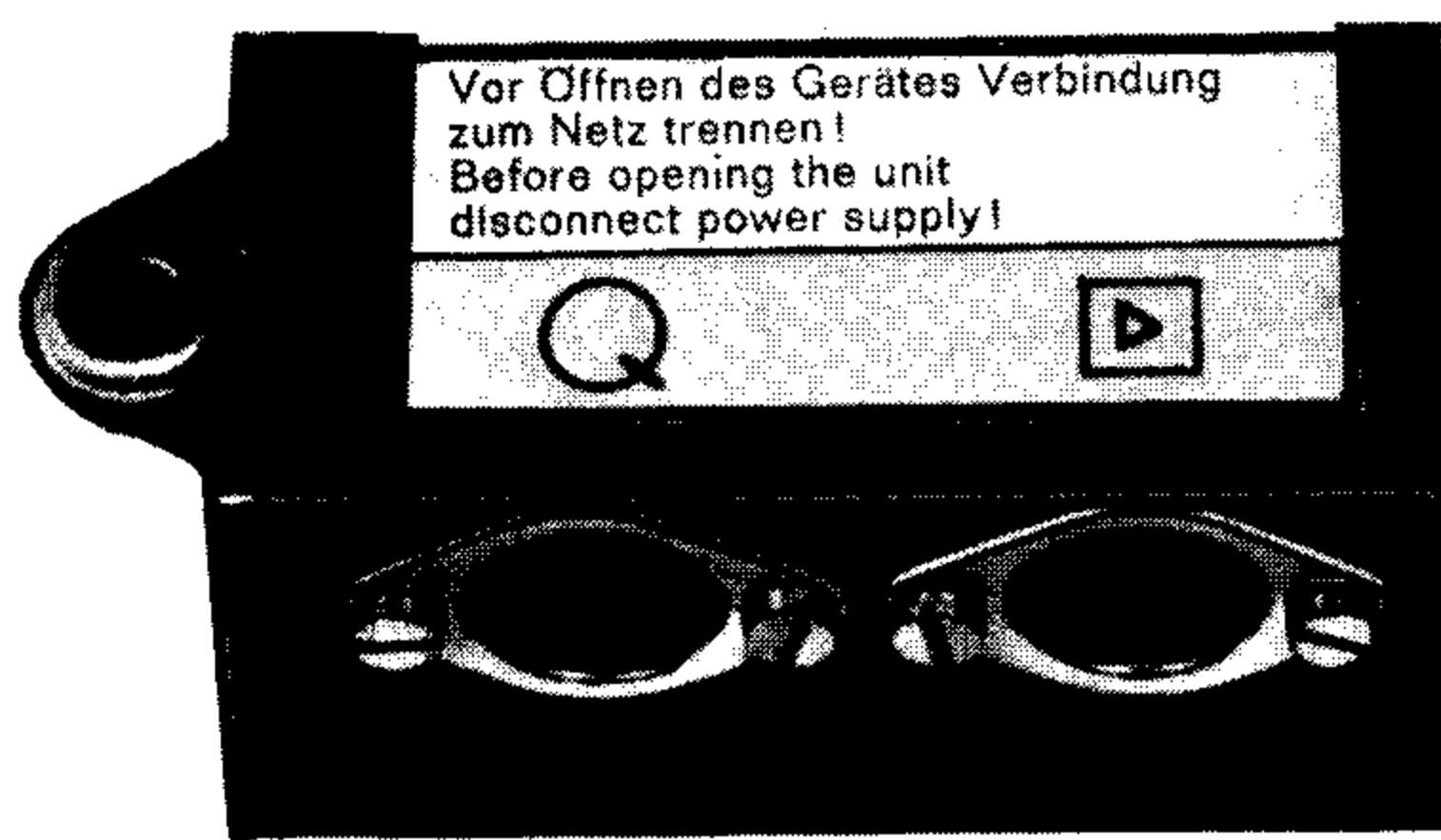

Fig. 5

## 2. NF-frequency connection

The pickup cable is plugged into the input connector designated  $\text{Q}$  (a five-contact receptacle per DIN 41 524), fig. 5.

The output of the TVV 46 appears at the receptacle designated  $\text{B}$ , into which the audio cable (Part No. 204 784) is plugged. The other end of the cable is connected to the phono input of the main amplifier.

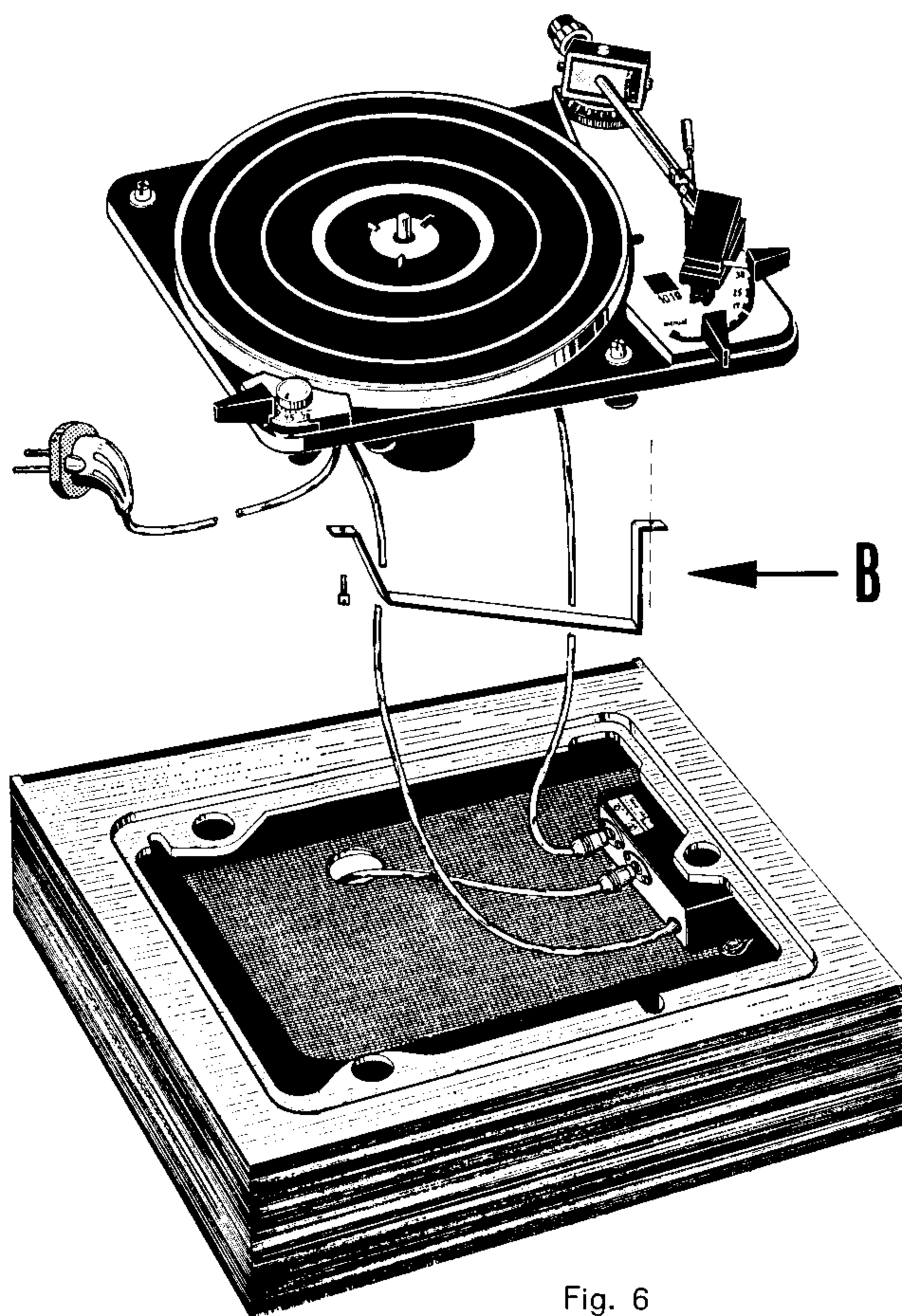

Fig. 6

## 3. Installation

a) The TVV 46 is easily installed into a compact assembly. Dual record player consoles and mounting bases are already fitted with the necessary openings, screws, washers, and nuts to facilitate mounting (see Fig. 6).

### b) Installation on Base CK 9

After mounting the TVV 46, unscrew the set-down guard (B) before inserting the record player.

## Technical Data

Frequency Response:

20 cps to 20 kcps  $\pm 1$  dB in accordance with 3180, 318 and 75  $\mu$ s

Distortion:

0.5% max. at 4 V output

Input Impedance:

approximately 47 k ohm at 1000 cps

Load Resistance:

100 k ohms minimum

Amplification:

100 times at 1000 cps

Signal-to-Noise Ratio:

80 dB below 4 V output

Transistor Complement:

4 Silicon Transistor BC 109  
Silicon diode 1 N 914

Line Requirements:

Alternating current, 110 V / 220 V, 40—60 cycles

Power Consumption:

about 2 watts at 220 V

Dimensions:

6 $\frac{1}{4}$ " x 2 $\frac{3}{4}$ " x 1 $\frac{1}{2}$ "

Weight:

14 oz

# Schaltschema Dual TVV 46 Wiring Diagram

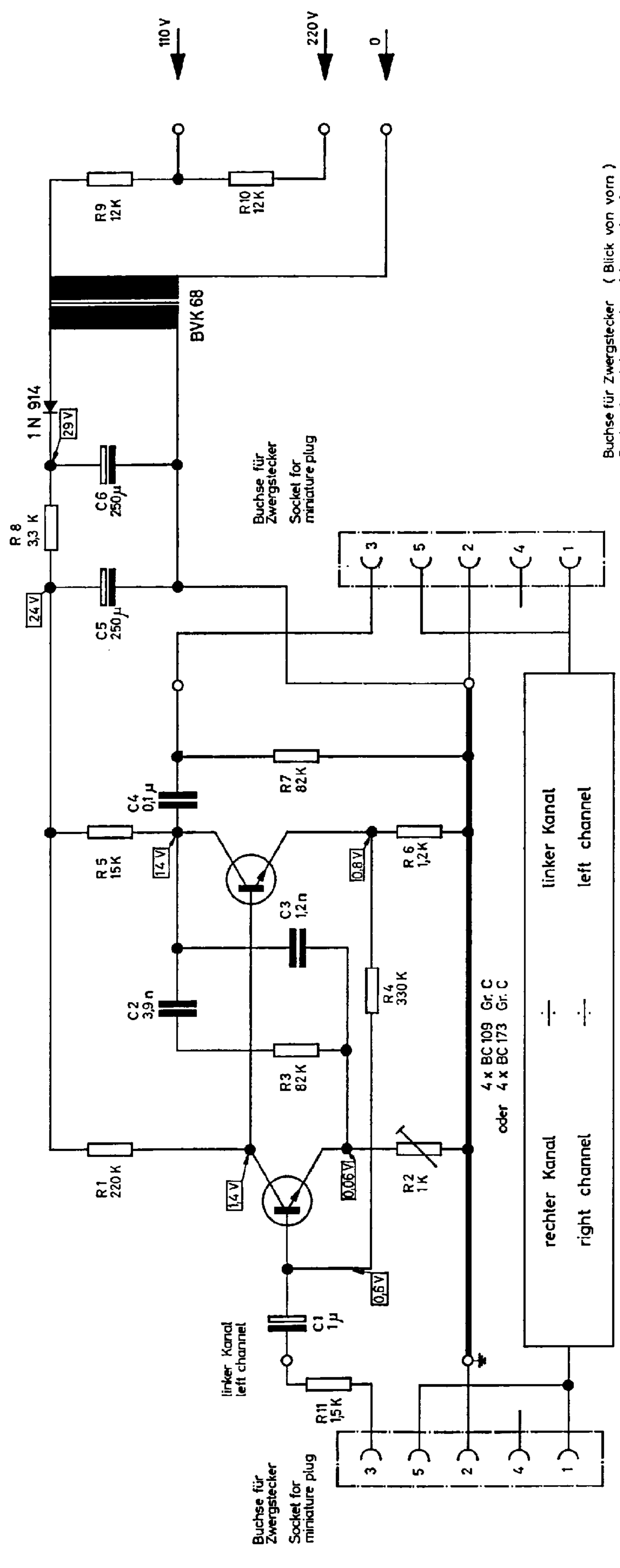

Buchse für Zwergstecker ( Blick von vorn )  
 Socket for miniature plug ( front view )

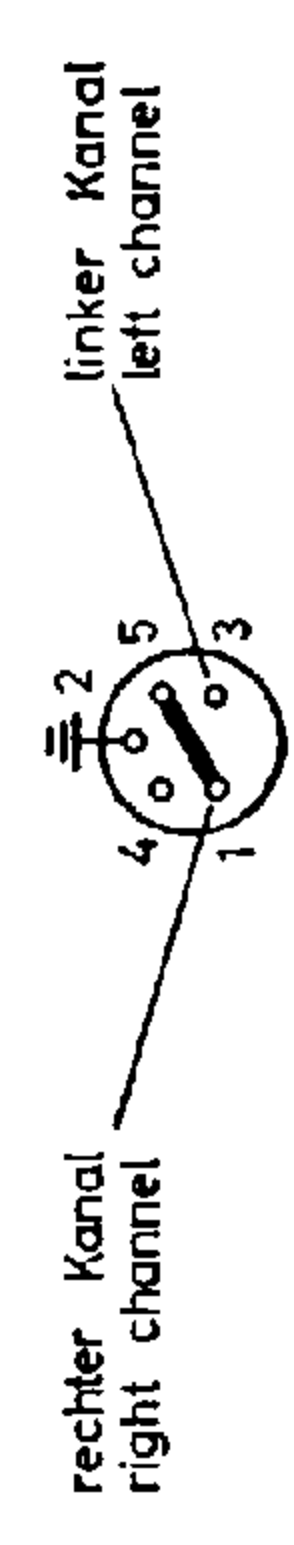

Änderungen vorbehalten !  
 Alteration reserved !

Spannungen gemessen mit Multizet ( 50 000Ω/V ) ohne Signal  
 Voltages measured with Multizet ( 50 000Ω/V ) without signal